



CEILING DISPLAY MOUNTS

FUSION™ VIDEO WALL FEATURES



CONTROLZONE™ LEVELING
Allows for 51 mm of height adjustment at each mounting box plus 25 mm increments along each column.



INDEPENDENT ADJUSTMENT
Separate knobs for micro-height and plumb adjustment help to easily align displays without tools.



INFINITE SCREEN POSITIONING
Infinite vertical and lateral shift adjustments allow for tight display rows and columns.



CABLE MANAGEMENT
FCACLIPS can be added at any point along the crossbars to create anchor points for easy cable management.



ADD EXTENSION
FCAX accessories increase rail length for larger displays, up to 152 cm.



INDEPENDENT
ADJUSTMENT



INFINITE SCREEN
POSITIONING

LCM3X3U LANDSCAPE VIDEO WALL



The landscape 3 wide x 3 tall configuration can be combined with other ceiling mounts to create longer walls. Fits 40 - 55" displays.

Weight Capacity (per screen)	Dimensions (HxWxD)	Mounting Patterns (W,H)	Manual Height Adjust	Micro Height Adjust
38.5 kg	1996 x 2763 x 368 mm	Any width x 100 - 400 mm	25 mm	51 mm

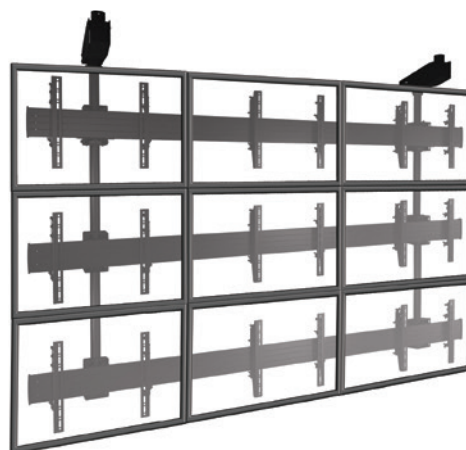

LCM3X2U LANDSCAPE VIDEO WALL



Create video walls in landscape orientation 3 wide x 2 tall. Fits 40 - 55" displays.

Weight Capacity (per screen)	Dimensions (HxWxD)	Mounting Patterns (W,H)	Manual Height Adjust	Micro Height Adjust
56.7 kg	1389 x 2766 x 368 mm	Any width x 100 - 400 mm	25 mm	51 mm

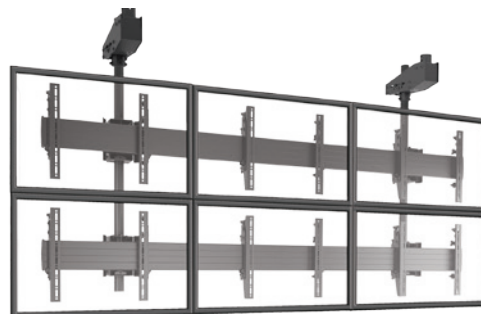

LCM3X2UP PORTRAIT VIDEO WALL



A portrait version to mount video walls 3 wide x 2 tall. Fits 40 - 55" displays.

Weight Capacity (per screen)	Dimensions (HxWxD)	Mounting Patterns (W,H)	Manual Height Adjust	Micro Height Adjust
56.7 kg	1996 x 1748 x 368 mm	100 - 800 mm x Any Height	25 mm	51 mm



LCM2X2U LANDSCAPE VIDEO WALL



The versatile and popular landscape 2 wide x 2 tall configuration fits well in most digital signage applications. Fits 40 - 55" displays.

Weight Capacity (per screen)	Dimensions (HxWxD)	Mounting Patterns (W,H)	Manual Height Adjust	Micro Height Adjust
56.7 kg	1389 x 1851 x 368 mm	Any width x 100 - 400 mm	25 mm	51 mm

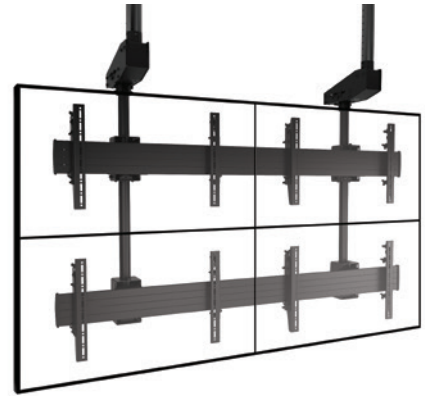

LCM2X2UP PORTRAIT VIDEO WALL







A portrait version to mount video walls 2 wide x 2 tall. Fits 40 - 55" displays.

Weight Capacity (per screen)	Dimensions (HxWxD)	Mounting Patterns (W,H)	Manual Height Adjust	Micro Height Adjust
56.7 kg	1996 x 1189 x 368 mm	100 - 800 mm x Any Height	25 mm	51 mm



FUSION™ MENU BOARD

FEATURES

- 
CONTROLZONE™ LEVELING
 Allows for 51 mm of height adjustment at each mounting box.
- 
CENTRIS™ TILT TECHNOLOGY
 Screens stay where you place them for effortless multi-screen alignment.
- 
TOOL-FREE SCREEN ENGAGEMENT
 Easily place screens and add optional padlock security.
- 
LATERAL SHIFT
 Post-installation lateral shift allows screens to slide apart or together for easy maintenance and perfect alignment.
- 
ADD EXTENSION
 FCAX accessories increase rail length for larger displays, up to 152 cm.



CONTROLZONE LEVELING



CENTRIS TILT TECHNOLOGY

LCM3X1U LANDSCAPE MENU BOARD



This classic menu board configuration is three screens across. Create longer menu boards by combining mounts. Fits 40 - 55" displays.

Weight Capacity (per screen)	Dimensions (HxWxD)	Mounting Patterns (W,H)	Micro Height Adjust	Tilt
56.7 kg	425 x 2766 x 201 mm	Any width x 100 - 400 mm	51 mm	+5°, -20°

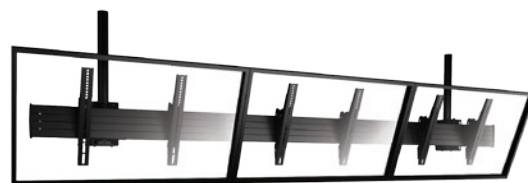

LCM3X1UP PORTRAIT MENU BOARD



The portrait of the LCM3X1U. Fits 40 - 55" displays.

Weight Capacity (per screen)	Dimensions (HxWxD)	Mounting Patterns (W,H)	Micro Height Adjust	Tilt
56.7 kg	826 x 1750 x 201 mm	100 - 800 mm x Any Height	51 mm	+5°, -20°

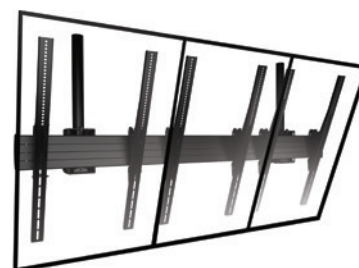

LCB3X1U BACK-TO-BACK LANDSCAPE



Mount three screens back-to-back in landscape orientation for six total screens. Fits 40 - 55" displays.

Weight Capacity (per screen)	Dimensions (HxWxD)	Mounting Patterns (W,H)	Micro Height Adjust	Tilt
56.7 kg	425 x 2763 x 292 mm	Any width x 100 - 400 mm	51 mm	+5°, -20°

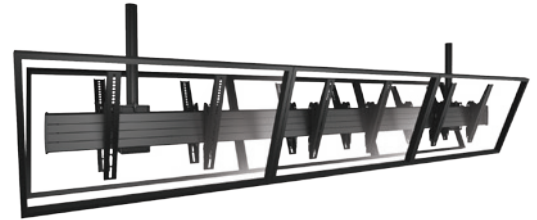

LCB3X1UP BACK-TO-BACK PORTRAIT



The portrait version of the LCB3X1U. Fits 40 - 55" displays.

Weight Capacity (per screen)	Dimensions (HxWxD)	Mounting Patterns (W,H)	Micro Height Adjust	Tilt
56.7 kg	826 x 1748 x 292 mm	100 - 800 mm x Any Height	51 mm	+5°, -20°

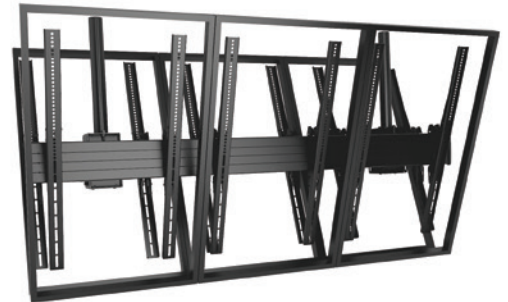

LCM2X1U LANDSCAPE MENU BOARD



This classic menu board configuration is two screens across. Create longer menu boards by combining mounts. Fits 40 - 55" displays.

Weight Capacity (per screen)	Dimensions (HxWxD)	Mounting Patterns (W,H)	Micro Height Adjust	Tilt
56.7 kg	427 x 1851 x 201 mm	Any width x 100 - 400 mm	N/A	+5°, -20°

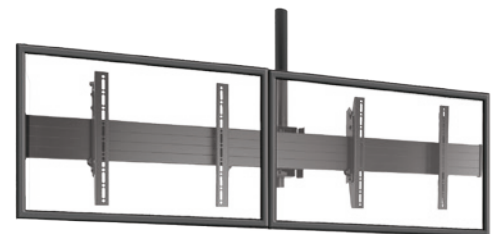

LCM2X1UP PORTRAIT MENU BOARD



The portrait version of the LCM2X1U. Fits 40 - 55" displays.

Weight Capacity (per screen)	Dimensions (HxWxD)	Mounting Patterns (W,H)	Micro Height Adjust	Tilt
56.7 kg	826 x 1190 x 201 mm	100 - 800 mm x Any Height	N/A	+5°, -20°

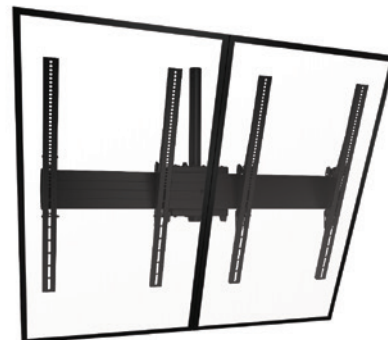

LCB2X1U BACK-TO-BACK LANDSCAPE



Mount two screens back-to-back in landscape orientation for four total screens. Fits 40 - 55" displays.

Weight Capacity (per screen)	Dimensions (HxWxD)	Mounting Patterns (W,H)	Micro Height Adjust	Tilt
45.4 kg	425 x 1851 x 296 mm	Any width x 100 - 400 mm	N/A	+5°, -20°

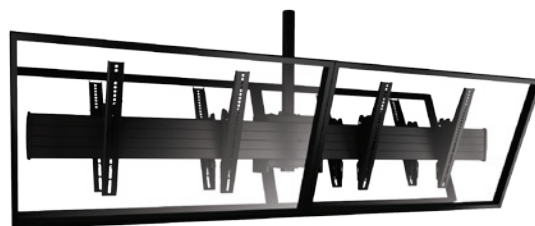

LCB2X1UP BACK-TO-BACK PORTRAIT



The portrait version of the LCB2X1U. Fits 40 - 55" displays.

Weight Capacity (per screen)	Dimensions (HxWxD)	Mounting Patterns (W,H)	Micro Height Adjust	Tilt
45.4 kg	826 x 1190 x 296 mm	100 - 800 mm x Any Height	N/A	+5°, -20°

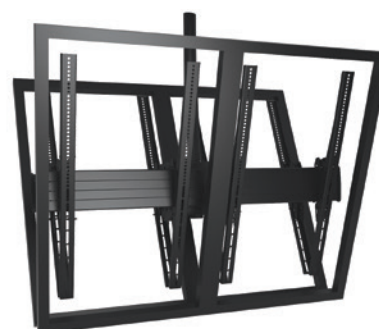

FUSION™ CEILING MOUNTS

FEATURES



CENTRIS™ TILT TECHNOLOGY

Provides a continuous range of fingertip tilt from +5 to -20 degrees with four set locking points at 0, 5, 10 and 15 degrees to eliminate guess work when adjusting multiple screens.



ON/OFF COLUMN CONNECTION

Simple connection for ease of installation and service, particularly when installing in tight corners or near walls.



TOOL-FREE SCREEN ENGAGEMENT

Easily place screens and add optional padlock security.



FLEXIBILITY

Mount swivels to any preferred viewing angle before locking down with set screws.

XCM7000 60 - 98" HEAVY-DUTY MOUNT



Dual pole drop provides needed support for single extra large and deep flat panel displays.



Weight Capacity	Dimensions (HxWxD)	Mounting Patterns (W,H)	Tilt	Roll Adjust
136 kg	425 x 884 x 203 mm	800 x 400 mm	+7.5° / -20°	2" total height adjust at each head assembly

XCB7000 60 - 90" BACK-TO-BACK HEAVY-DUTY MOUNT



Dual pole drop provides needed support for back-to-back configurations of extra large and deep flat panel displays.



Weight Capacity (per screen)	Dimensions (HxWxD)	Mounting Patterns (W,H)	Tilt	Roll Adjust
136 kg	425 x 884 x 300 mm	800 x 400 mm	+7.5° / -20°	2" total height adjust at each head assembly

XCM1U 60 - 90" LANDSCAPE CEILING MOUNT



For heavier displays with wider mounting patterns.

Weight Capacity	Dimensions (HxWxD)	Mounting Patterns (W,H)	Tilt	Roll Adjust
113.4 kg	425 x 884 x 201 mm	200 x 100 - 800 x 400 mm	+5°, -20°	±3°

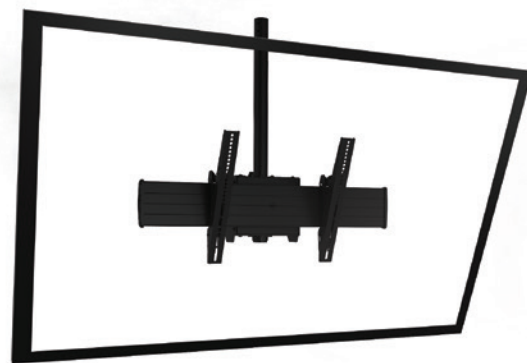

XCB1U 60 - 90" BACK-TO-BACK LANDSCAPE MOUNT



Back-to-back version of the XCM1U to mount two displays with wider mounting patterns.

Weight Capacity (per screen)	Dimensions (HxWxD)	Mounting Patterns (W,H)	Tilt	Roll Adjust
90.7 kg	425 x 884 x 296 mm	200 x 100 - 800 x 400 mm	+5°, -20° for screens up to 38.8" tall	±3°

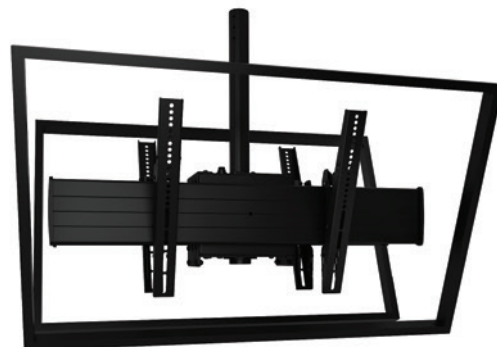

LCM1U LANDSCAPE CEILING MOUNT



Our most popular, feature-packed and versatile single ceiling mount fits most 32 - 60" displays. Add another for stacked configurations.

Weight Capacity	Dimensions (HxWxD)	Mounting Patterns (W,H)	Tilt	Roll Adjust	Color
56.7 kg	420 x 681 x 162 mm	200 x 100 - 616 x 400 mm	+5°, -20°	±3°	S B

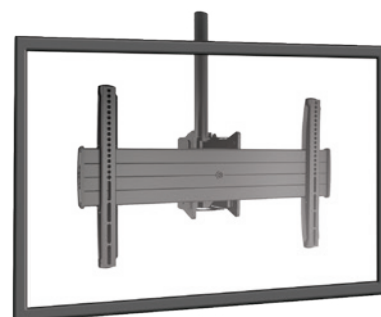

LCM1UP PORTRAIT CEILING MOUNT



The portrait version of the LCM1U. Fits 32 - 60" displays.

Weight Capacity	Dimensions (HxWxD)	Mounting Patterns (W,H)	Tilt	Roll Adjust	Color
56.7 kg	826 x 529 x 162 mm	200 x 100 - 460 x 800 mm	+5°, -20°	±3°	S B

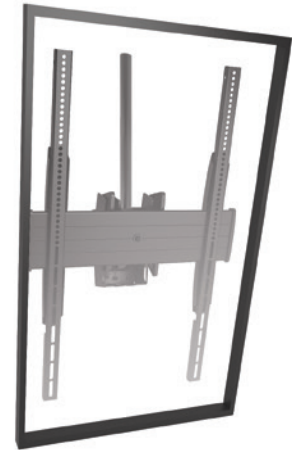

LCB1U BACK-TO-BACK LANDSCAPE MOUNT



The back-to-back version of the LCM1U for two total screens in a landscape configuration. Fits 32 - 60" displays.

Weight Capacity (per screen)	Dimensions per mount (HxWxD)	Mounting Patterns (W,H)	Tilt	Roll Adjust	Color
56.7 kg	420 x 681 x 259 mm	200 x 100 - 616 x 400 mm	+5°, -20°	±3°	B

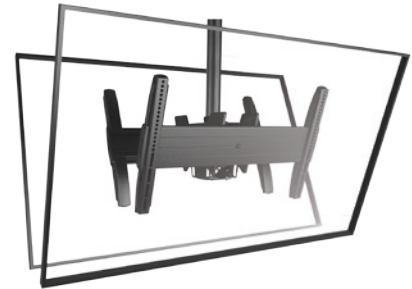

LCB1UP BACK-TO-BACK PORTRAIT MOUNT



The portrait version of the LCB1U. Fits 32 - 60" displays.

Weight Capacity (per screen)	Dimensions per mount (HxWxD)	Mounting Patterns (W,H)	Tilt	Roll Adjust	Color
56.7 kg	826 x 529 x 259 mm	200 x 100 - 460 x 800 mm	+5°, -20°	±3°	B



LCM1X2U 32 - 60" STACKED LANDSCAPE



This solution includes two LCM1U mounts and a 121.9 cm perforated CPA column for stacking two screens on the same column.

Weight Capacity (per screen)	Dimensions per mount (HxWxD)	Mounting Patterns (W,H)	Tilt	Roll Adjust	Color
56.7 kg	420 x 681 x 162 mm	200 x 100 - 616 x 400 mm	+5°, -20°	±3°	B

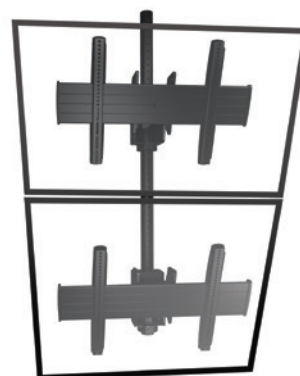

LCB1X2U 32 - 60" BACK-TO-BACK STACKED



The back-to-back version of the LCM1x2U stacks two screens per side for four total screens and a 121.9 cm perforated CPA column.

Weight Capacity (per screen)	Dimensions per mount (HxWxD)	Mounting Patterns (W,H)	Tilt	Roll Adjust	Color
45.3 kg	420 x 681 x 259 mm	200 x 100 - 616 x 400 mm	+5°, -20°	±3°	B



LCM4U 32 - 65" QUAD MOUNT



Allows four screens to be installed on a single column drop for 360° viewing capabilities. Comes with Fusion interfaces.

Weight Capacity (per screen)	Dimensions per mount (HxWxD)	Mounting Patterns (W,H)	Tilt	Roll Adjust	Color
38 kg	475 x 1422 x 1422 mm	200 x 200 - 600 x 400 mm	+5°, -20°	±3°	B

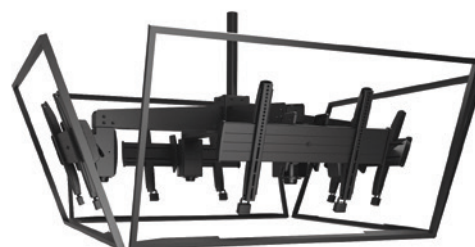

LCM3U 32 - 65" TRIPLE MOUNT



Allows three screens to be installed on a single column drop for 360° viewing capabilities. Comes with Fusion interfaces.

Weight Capacity (per screen)	Dimensions per mount (HxWxD)	Mounting Patterns (W,H)	Tilt	Roll Adjust	Color
57 kg	462 x 1184 x 1184 mm	200 x 200 - 600 x 400 mm	+5°, -20°	±3°	B

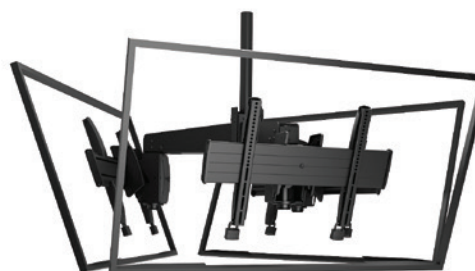

MCM1U 26 - 50" CEILING MOUNT



The medium version of the LCM1U accommodates smaller mounting patterns as well as portrait and landscape orientations.

Weight Capacity	Dimensions (HxWxD)	Mounting Patterns (W,H)	Tilt	Roll Adjust	Color
56.7 kg	420 x 529 x 162 mm	200 x 100 - 460 x 400 mm	+5°, -20°	±3°	S B



MCB1U 26 - 50" BACK-TO-BACK LANDSCAPE



Back-to-back version of the MCM1U for two total screens in landscape or portrait configurations. Fits 26 - 50" displays.

Weight Capacity (per screen)	Dimensions per mount (HxWxD)	Mounting Patterns (W,H)	Tilt	Roll Adjust	Color
56.7 kg	419 x 529 x 259 mm	200 x 100 - 460 x 400 mm	+5°, -20°	±3°	B



MCM1X2U 26 - 50" STACKED LANDSCAPE



Stacked solution includes two MCM1U mounts and a 121.9 cm perforated CPA in a 1 wide x 2 tall configuration.

Weight Capacity (per screen)	Dimensions per mount (HxWxD)	Mounting Patterns (W,H)	Tilt	Roll Adjust	Color
56.7 kg	419 x 529 x 162 mm	200 x 100 - 460 x 400 mm	+5°, -20°	±3°	B



MCB1X2U 26 - 50" BACK-TO-BACK STACKED



Back-to-back version of the MCM1x2U stacks two screens per side for four total screens and a 121.9 cm perforated CPA column.

Weight Capacity (per screen)	Dimensions per mount (HxWxD)	Mounting Patterns (W,H)	Tilt	Roll Adjust	Color
45.3 kg	420 x 529 x 259 mm	200 x 100 - 460 x 400 mm	+5°, -20°	±3°	B



FUSION™ VIDEO WALL, MENU BOARD & CEILING MOUNT ACCESSORIES



FCAX08/14/20		Compatibility
Video Wall Extension Brackets		Fusion Video Wall & Menu Board Ceiling Mounts
Model	Length	
FCAX08	203 mm	
FCAX14	356 mm	
FCAX20	508 mm	



FCAC		Compatibility
Menu Board Connector*		Fusion Ceiling-Mounted Menu Boards

* For alignment and aesthetics only - not for bearing load.



FCA3U		Compatibility
Triple Ceiling Mount Adapter		Allowing for integration of different mount heads like the LCM1U, MCM1U, RLC1, RMC1 and JHS mounts



FCA4U		Compatibility
Quad Ceiling Mount Adapter		Allowing for integration of different mount heads like the LCM1U, MCM1U, RLC1, RMC1 and JHS mounts



FCA500	Shelf Dim. (WxD)	Weight Capacity	Compatibility
Component / Video Conference Shelf - Below	457 x 287 mm	9.1 kg	Fusion Landscape Ceiling & Freestanding Mounts



FCA501/502		Compatibility
Component / Video Conference Shelves - Above		Fusion Landscape Ceiling & Freestanding Mounts
Model	Shelf Dimensions (WxD)	Weight Capacity
FCA501	356 x 254 mm	4.5 kg
FCA502	203 x 254 mm	4.5 kg



FCA800/ FCA801*		Compatibility
Above/Below Shelf, Large* Displays		Fusion Fixed & Tilt Wall, Freestanding & Ceiling Mounts
Model	Size	Weight Capacity
FCA800	203 mm	9.1 kg
FCA801	355 mm	9.1 kg

* Typical screen size: 46-70".
* Available spring, 2015.



FCA810/ FCA811*		Compatibility
Above/Below Shelf, XL* Displays		Fusion Fixed & Tilt Wall, Freestanding & Ceiling Mounts
Model	Size	Weight Capacity
FCA810	203 mm	9.1 kg
FCA811	355 mm	9.1 kg

* Typical screen size: 70-100".
* Available spring, 2015.



FCA820/ FCA821*		Compatibility
Fusion Center Camera Shelf		Fusion Ceiling, Freestanding and Wall Mounts
Model	Size	Weight Capacity
FCA820	203 mm	9.1 kg
FCA821	355 mm	9.1 kg

* Available spring, 2015.



FCA510/515		Compatibility
Storage Accessories		All Fusion Ceiling & Freestanding Mounts
Model	Dimensions (HxWxD)	
FCA510	267 x 267 x 76 mm	
FCA515	394 x 394 x 114 mm	



FUSION™ VIDEO WALL, MENU BOARD & CEILING MOUNT ACCESSORIES



FCA520	Max Equipment Depth	Compatibility
Universal Clamp Kit (Qty 2)	83 mm	All Fusion Ceiling & Freestanding Mounts



FCACLIPS	Compatibility
Anchor Points for Zip Ties (Qty 10)	All Fusion Ceiling & Freestanding Mounts



FCA530	Weight Capacity	Compatibility
Center Channel Speaker Adapter	9.1 kg	Fusion Landscape Ceiling & Freestanding Mounts



FCA830/ FCA840*	Compatibility	
Center Channel Speaker Adapter	Fusion Fixed & Tilt Wall, Freestanding & Ceiling Mounts	
Model	Typical Screen Size	Weight Capacity
FCA830	52 - 80"	9.1 kg
FCA840	70 - 100"+	9.1 kg

* Available spring, 2015.



FCA535	Weight Capacity	Compatibility
Left/Right Speaker Adapters	4.5 kg per side	All Fusion Ceiling & Freestanding Mounts



FCA831/ FCA841*	Compatibility	
Center Channel Speaker Adapter	Fusion Fixed & Tilt Wall, Freestanding & Ceiling Mounts	
Model	Typical Screen Size	Weight Capacity
FCA831	42 - 70"	4.5 kg/side
FCA841	50 - 95"	4.5 kg/side

* Available spring, 2015.

THREADED COLUMN CEILING ACCESSORIES



CMS115	Weight Capacity
Speed-Connect Ceiling Plate	226.8 kg
Model	Color
CMS115	B (shown)
CMS115W	W



CMA330	Weight Capacity
Offset Ceiling Plate - 203 mm	226.8 kg



CMA345	Weight Capacity
Shock Absorption Ceiling Plate	226.8 kg



CMA395	Weight Capacity
Angled Ceiling Plate	226.8 kg
Model	Color
CMA395	B (shown)
CMA395W	W



CMA360	Weight Capacity
I-Beam Clamp	113.4 kg



CMA365	Weight Capacity
Truss Ceiling Adapter	113.4 kg



CMA351	Weight Capacity
Heavy Duty Swivel Adapter	226.8 kg



CMA274/275	Compatibility
Quick-Snap Cable Covers (Qty 1 / 3)	1-1/2" & 2" NPT Columns



CMS Fixed Columns	Weight Capacity		
Fixed 1-1/2" NPT extension columns available in black and white†	226.8 kg		
Model	Length	Model	Length
CMS003*	76 mm	CMS018	457 mm
CMS006*	152 mm	CMS024	0.6 m
CMS009	229 mm	CMS036	0.9 m
CMS012	305 mm		

* Steel construction. † All part numbers listed are black. To order white add a W to the end of the part number.



CMS Adjustable Columns	Weight Capacity		
Adjustable 1-1/2" NPT extension columns available in black and white†	226.8 kg		
Model	Length	Model	Length
CMS006009	152-229 mm	CMS0203	0.6-0.9 m
CMS009012	229-305 mm	CMS0305	0.9-1.5 m
CMS012018	305-457 mm	CMS0406	1.2-1.8 m
CMS018024	457-610 mm	CMS0507	1.5-2.1 m

* Cannot ship by UPS due to length. † All part numbers listed are black. To order white add a W to the end of the part number.



CMA640	Compatibility
Decorative Ring, 48 mm ID	1-1/2" NPT & CPA Columns
Model	Color
CMA640	C (shown)
CMA640B	B
CMA640W	W



CMA643	Compatibility	Color
Decorative Ring, 62 mm ID	CMS Outer Adjustable Columns	S

CPA PIN CONNECTION ACCESSORIES



CPA330	Weight Capacity
CPA Offset Ceiling Plate	226.8 kg



CPA395	Weight Capacity
CPA Angled Ceiling Plate	226.8 kg



CPA365	Weight Capacity
CPA Truss Adapter	226.8 kg



CPA262	Weight Capacity
CPA to NPT Column Connection Adapter (contains male 1-1/2" NPT threads and accepts Chief CPA columns)	226.8 kg
Model	Color
CPA262	B (shown)
CPA262S	S



CPA263	Weight Capacity
CPA column to CPA column connector	226.8 kg



CPA264	Weight Capacity
NPT to CPA Column Connection Adapter (contains female 1-1/2" NPT threads and accepts Chief's CPA columns)	226.8 kg



CPA Columns	Weight Capacity
Fixed, pin-connection extension columns available in black, silver and white†	226.8 kg
Model	Length
CPAE030	300 mm
CPAE080	800 mm
CPAE100	1000 mm
CPAE150	1500 mm
CPAE300	3000 mm
† All part numbers listed are black. To order alternate colors add an S (silver) or W (white) to the end of the part number.	



CMA274	Compatibility
Quick-Snap Cable Cover	CPA Columns



CMA275	Compatibility
Quick-Snap Cable Covers (3 pack)	CPA Columns